

sistemi e soluzioni di arredo

furnishing systems and solutions



GIBAM

 **composit**

> **B05**



Gibam Composit è un prodotto

GIBAM SHOPS



B05

Ogni progetto è unico. Attorno a questa idea è nato B05.

Un sistema componibile **altamente tecnologico**, concepito su principi di **semplicità e modularità**. Un prodotto pensato per accogliere **la più vasta gamma di accessori per il retail** presente sul mercato. Linee semplici e pulite, personalizzabili a 360° grazie ad una **esclusiva gamma di materiali**. Tutto questo è B05, perché voi ed il vostro negozio siete unici.

Every project is unique. Around this idea was born B05.

A high-tech modular system, devised on the principles of **simplicity and modularity**. A product designed to accommodate the **widest range of accessories for retail** on the market. Simple, clean lines, customizable 360 ° thanks to an **exclusive range of materials**. All this is B05, because you and your business are unique.

Il prodotto

Come è stato progettato [p.07](#) Come lo vede il cliente [p.09](#) Come lo vede l'operatore [p.11](#) Come comporre B05: la struttura [p.13](#) Come personalizzare B05: gli accessori [p.15](#)

Le applicazioni

Farmacia [p.19](#) Gioielli [p.21](#) Abbigliamento [p.23](#) Ottica [p.25](#) Reception [p.27](#) Merceria [p.29](#) Libreria [p.31](#) Tabacchi [p.33](#) Fioreria [p.35](#) Elettronica [p.37](#)

The product

The way we designed it [p.07](#) The way the client sees it [p.09](#) The way the operator sees it [p.11](#) How to compose B05: the structure [p.13](#) How to "dress up" B05: the accessories [p.15](#)

The applications

Pharmacy [p.19](#) Jewellery [p.21](#) Fashion [p.23](#) Optical shop [p.25](#) Reception [p.27](#) Haberdashery [p.29](#) Bookstore [p.31](#) Tobacconist [p.33](#) Flower shop [p.35](#) Electronics [p.37](#)



Come è stato progettato. The way we designed it.

Robustezza Strength

Servizio clienti e zona cassa sono le aree più vissute in un punto vendita. Il banco B05 si distingue dagli standard di settore per le sue doti tecniche e l'elevata resistenza, rivoluzionando quindi il concetto di usura.

Inside a point of sale the most stressed area is that dedicated to customer service and cashier. The use of materials characterised by long durability puts B05 above the common standards, and makes a statement about the resistance to wear.

Funzionalità Functionality

B05 è stato studiato non solo come punto di appoggio o esposizione prodotti, ma come vero e proprio "centro nevralgico" all'interno del punto vendita. L'ampia gamma di accessori dedicata permette di configurare la zona retro banco secondo specifiche esigenze.

B05 has been devised not only as a place to put things down or as a showcase, but as a real center of relationship with the client. The product is furtherly completed by a large range of accessories and by the possibility to configure its back side in accordance to need.

Estetica Aesthetics

Il bello è funzionale. L'estetica minimale che caratterizza B05 si traduce in soluzioni semplici ed efficaci. L'estrema cura nella scelta dei materiali e delle superfici si traduce in un'esperienza piacevole alla vista e al tatto.

Beautiful and functional. The minimalistic aesthetics of B05 becomes simple and down-to-point solutions. Materials and surfaces chosen with great care create a pleasant visual and sensorial experience.

Convenienza Convenience

Tante idee per personalizzare B05. Una filosofia che permette di ottimizzare le risorse del retailer lasciando spazio solo a ciò che ritiene necessario. A questo si aggiunge la tecnologia LED che annulla quasi totalmente il concetto di "manutenzione" nel tempo e assicura un notevole risparmio dei consumi.

Many solutions from which to choose for the customization of B05. A philosophy that allows to optimize the resources of the retailer only taking what is necessary. To this we add the use of LED technology, that reduces to almost zero the need for maintenance over time, and becomes a money saver.



Come lo vede il cliente. The way the client sees it.

Esposizione

Vetrina ad angolo per l'esposizione di prodotti speciali.

Display solutions

Corner glass case for the display of special products.

Servizio e Assistenza

Bancalina in vetro satinato per il punto servizio/cassa.

Service and assistance

Frosted glass elevated top for the service/cashier desk.

Esposizione

Gradinale telefonica per l'esposizione "al tocco".

Display solutions

Step display for touchable mobile phones.

Esposizione

Esposizione verticale multifunzionale.

Display solutions

Vertical display.

Comunicazione

Fronte stampato con grafica personalizzata.

Communication

Printed front with thematic prints.

Servizio e Assistenza

Ripiano luminoso poggia borse.

Service and assistance

Lit shelf for bags.

Comunicazione

Box luminoso per la comunicazione.

Communication

Communication box with light.



Come lo vede l'operatore. The way the operator sees it.

Organizzazione
Cassettiera.

Organization
Chest of drawers.

Esposizione

Esposizione verticale
multifunzionale.

Display solutions

Multifunctional vertical
display panel.

**Servizio e
Assistenza**

Bancalina in vetro
satinato per il punto
servizio/cassa.

**Service and
assistance**

Frosted glass front top
for the service/cashier
area.

Esposizione

Vetrina espositiva con
illuminazione.

Display solutions

Display glass case with
light.

**Servizio e
Assistenza**

Volume di assistenza e
scrivania.

**Service and
assistance**

Assistance and general
desk unit.

Organizzazione
Ripiano a giorno porta
stampante.

Organization
Printer shelf.

Organizzazione
Contenitore porta buste
in plexiglas opale.

Organization
Bag container in milky
acrylic.

Organizzazione
Contenitore grucce.

Organization
Space for hanging
clothes in milky acrylic.

Organizzazione
Vano multifunzionale con
ante.

Organization
Multifunctional cabinet.

Come comporre B05: la struttura.

How to compose B05: the structure.

Il Top

Il Top, attrezzato con o senza foro passacavo, è disponibile in una vastissima gamma di materiali.

The Top

The desk top surface, available with or without cable hole, can be produced in a very large range of materials.

La scocca

Attraverso l'unione del volume dritto e degli angoli interni ed esterni è possibile sviluppare ogni forma di layout.

The Body

The combination of the straight unit and of internal and external corners allows to develop many different shapes.

Il Frontale

Frontale e Top si abbinano perfettamente e prevedono entrambi la stampa digitale con grafica personalizzata.

The Front Panel

The Front Panel continues the top surface and can be customised also with printed materials from pictures.

Lo zoccolo

Lo Zoccolo, in plastica pvc disponibile nel colore bianco o nero, si abbina perfettamente alla struttura ed è facile da pulire.

The Skirting Board

The Skirting Board, made of PVC, available in white or black colours, perfectly matches the structures and it's easy to clean.

Il Fianco

I due Fianchi laterali terminano la composizione e si abbinano alla Scocca e allo Zoccolo.

The Side

The two sides end the product and are harmonised in finish with the body and the skirting board.

Dimensioni:
Dimensions:

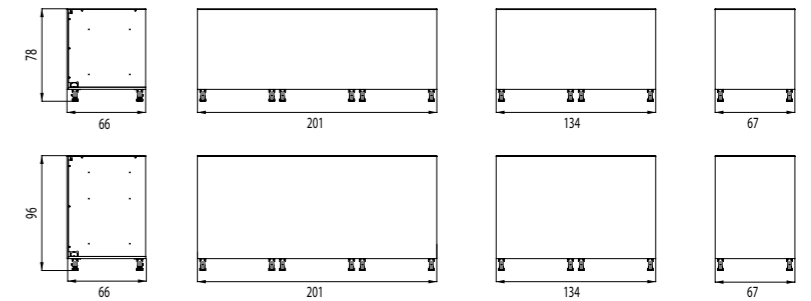

Tutto quello che vuoi con la massima semplicità. Abbiamo disegnato un sistema semplice e veloce da progettare, per permettervi di gestire anche le soluzioni più complesse in termini di gestione dello spazio. Un unico modulo in due altezze combinabili tra loro permettono di moltiplicare le soluzioni funzionali a disposizione del progettista. I rivestimenti, in vetro, legno e materiali compositi possono essere applicati a qualsiasi soluzione di layout.

Possibili combinazioni:

Possible combinations:

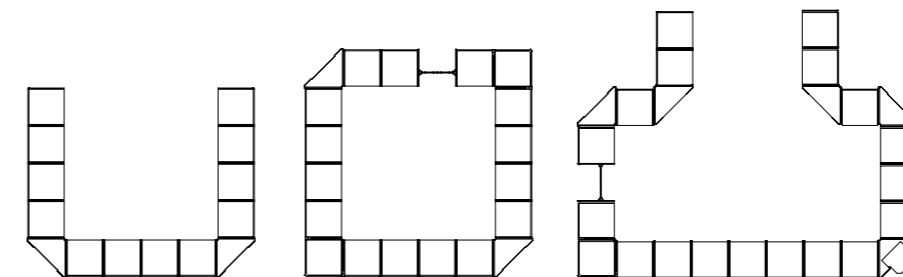
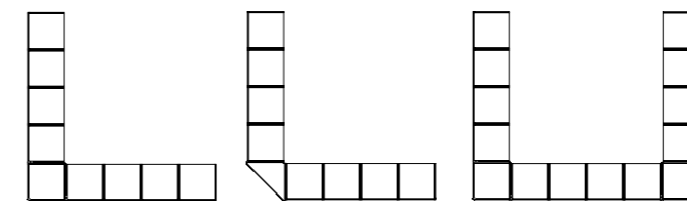
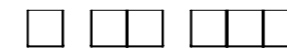

Everything you may want with the greatest simplicity. We have designed a system that is simple yet quick to be used, suitable to be applied to the most complex situations of space management. One module presented with two combinable heights that allow to create multiple functional solutions. The various surface finishing materials, as glass, wood and composites can be used in every layout solution.

Esposizione

Vetrine, gradinali al "tocco", ripiani, ecc. presentano il prodotto al meglio, trasformando il banco in un valido sistema espositivo.

Display solutions

Glass cases, step display elements for touchable products, shelves give visibility to the products and transform the counter in a valid display system.



Servizio

Gli accessori che completano le aree dedicate alla vendita assistita sono pensati per garantire il massimo comfort all'operatore e al cliente.

Service

The accessories that complete the areas dedicated to assisted sale are devised to guarantee maximum comfort to both operator and client.

Organizzazione

Cassetteria, ripiano porta tastiera, vano porta buste, sono solo alcuni degli accessori pensati per agevolare al meglio l'operatore nell'organizzazione del proprio spazio lavoro.

Organization

Chest of drawers, keyboard support, bags container, are just some of the accessories created for the operator and aimed at organise the working space.



Come personalizzare B05: gli accessori.

How to "dress" B05: the accessories.

B05 è il luogo in cui si incontrano gli aspetti legati alla gestione del punto vendita e quelli più vicini al rapporto con il cliente. Un'efficace strumento di lavoro. Una eccezionale gamma di accessori, pensati attorno a chi lavora ed alle sue esigenze specifiche, permette di attrezzare un banco altamente funzionale e professionale. La qualità dei materiali e delle finiture, la chiarezza espositiva e di servizio garantiti da B05, contribuiscono nel rinforzare la vostra immagine di retailer agli occhi dei clienti.

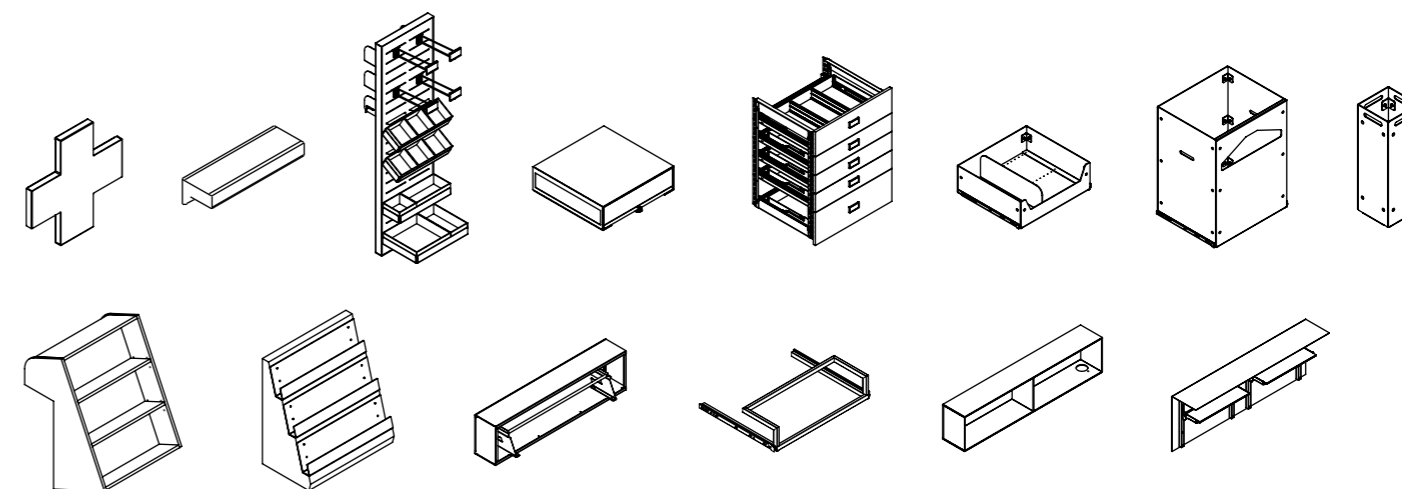

B05 is the place where the aspects related to the management of the store and the ones closest to the customer relationship meet. An effective working tool. An exceptional range of accessories designed around the people who work and its needs, allows you to equip a counter highly functional and professional. The quality of materials and finishes, the clarity of the displays and of the service guaranteed service by B05, help in reinforcing your image as a retailer in the eyes of clients.

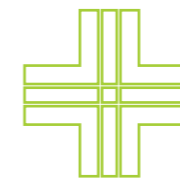

Farmacia
Pharmacy

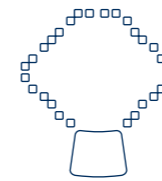

Gioielleria
Jewellery



Abbigliamento
Fashion



Ottica
Optical shops



Reception
Reception



Merceria
Haberdashery



Libreria
Bookstore

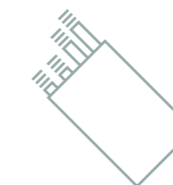

Tabacchi
Tobacconist



Fioreria
Flower shop



Elettronica
Electronics

Total white e legno per la farmacia.

Full white and wood for the pharmacy.



1. Croce luminosa. 2. Cassettiera generica. 3. Cassettiera per farmacia. 4. Espositore verticale multifunzionale - Lato cliente. 5. Espositore verticale multifunzionale - Lato operatore. 6. Vetrina bassa. 7. Ripiano luminoso poggia borsa.

1. Lit cross. 2. General drawers. 3. Pharmacy drawers. 4. Vertical multifunctional display panel - Client side. 5. Vertical multifunctional display panel - Operator side. 6. Short glass case. 7. Lit bag holding shelf.

“Studiati per”
“Devised for”



Croce luminosa
Lit cross



Piano poggiaborse
Bag holding shelf



Totem espositivo
Display totem



Vetrina bassa
Short glass case



Cassettiera
Chest of drawers

*Attenzione: l'elenco sopra è puramente indicativo, gli accessori possono essere utilizzati per più categorie merceologiche.
*Warning: The above list is only indicative, the accessories can be used for more than one category.

Deluxe futurista per l'esposizione gioielli.

Futuristic touch for jewels display.



1.2.3 Vetrina bassa. 4. Cash drawer. 5. Vano porta shoppers.

1.2.3 Short glass case. 4. Cash drawer. 5. Bag container.



"Studiati per"
"Devised for"



Vetrina alta
Tall glass case



Vetrina bassa
Short glass case

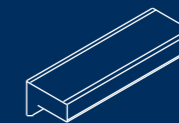

Piano poggiaborse
Bag holding shelf



Cash drawer
Cash drawer

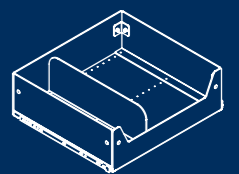

Vano porta shoppers
Bag container

*Attenzione: l'elenco sopra è puramente indicativo, gli accessori possono essere utilizzati per più categorie merceologiche.
*Warning: The above list is only indicative, the accessories can be used for more than one category.

Denim Style con top retro stampato per l'abbigliamento.

Denim Style and back-printed top for the fashion shop.



1. Cash drawer. 2. Tiretto tastiera. 3. Vano porta shoppers. 4. Gancera abiti venduti. 5. Vano porta grucce. 6. Vano porta antitaccheggio.

1. Cash drawer. 2. Keyboard holder. 3. Bag container. 4. Hook for sold items. 5. Hangers container. 6. Container for anti-theft tags.



"Studiati per"
"Devised for"

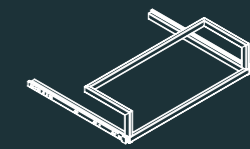

Gancera abiti venduti
Hook for sold items

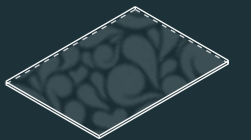

Top retro stampato
Back-printed top



Cash drawer
Cash drawer

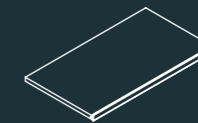

Tiretto tastiera
Keyboard holder

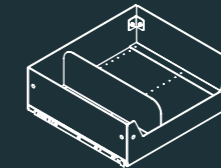

Vano porta shoppers
Bag container

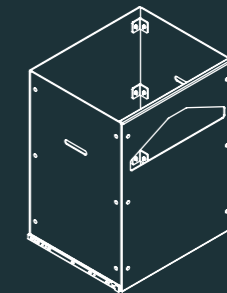

Contenitore grucce
Hangers container

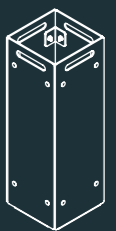

Vano porta antitaccheggio
Container for anti-theft

*Attenzione: l'elenco sopra è puramente indicativo, gli accessori possono essere utilizzati per più categorie merceologiche.
*Warning: The above list is only indicative, the accessories can be used for more than one category.

Industrial trends per l'arredo ottica.

Industrial trends for optical shops.



1.2.3. Vetrina bassa e gradinale porta occhiali.
4. Angolare top, frontale e fianco. 5. Bancalina in vetro satinato.

1.2.3. Short glass case and eyeglasses step display. 4. A Corner of top, front panel and side panel. 5. Frosted glass elevated top.

"Studiati per"
"Devised for"

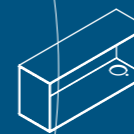

Bancalina in vetro singola
Single glass elevated top

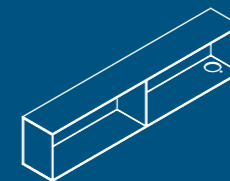

Bancalina in vetro doppia
Double glass elevated top



Vetrina alta
Tall glass case

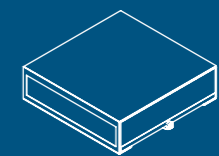

Vetrina bassa
Short glass case

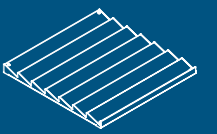

Gradinale porta occhiali
Eyeglasses step display

*Attenzione: l'elenco sopra è puramente indicativo, gli accessori possono essere utilizzati per più categorie merceologiche.
*Warning: The above list is only indicative, the accessories can be used for more than one category.

"Less is more" per l'area reception.

"Less is more" for the reception area.



1. Bancalina in metallo. 2. Spigolo di top, frontale e fianco. 3. Tiretto tastiera. 4.5. Foro passacavi del top 6. Cassetiera. 7. Piano poggaborse.

1. Metal elevated top. 2. Corner of top, front panel and side panel. 3. Keyboard holder. 4.5. Top cables hole 6. Drawers. 7. Bag holding shelf.

"Studiati per"
"Devised for"



Bancalina in metallo singola
Single metal elevated top

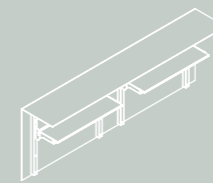

Bancalina in metallo doppia
Double metal elevated top



Tiretto tastiera
Keyboard holder

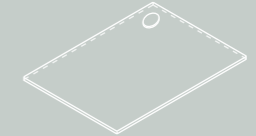

Top con foro passacavi
Top with cable hole



Cassetiera
Drawers

*Attenzione: l'elenco sopra è puramente indicativo, gli accessori possono essere utilizzati per più categorie merceologiche.
*Warning: The above list is only indicative, the accessories can be used for more than one category.

Ambiente caldo e accogliente per la merceria. Warm and welcoming environment for the haberdashery.



1.2.3. Vetrina bassa.
4. Zoccolo colore nero. 3. Top retro stampato.

1.2.3. Short glass case. 4. Black skirting board. 3. Back-printed top.

"Studiati per"
"Devised for"



Vetrina alta
Tall glass case



Vetrina bassa
Short glass case



Cash drawer
Cash drawer

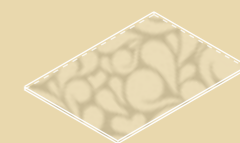

Top retro stampato*
Back-printed top*



* L'utilizzo del top retro stampato permette di caratterizzare il punto vendita con grafiche "a tema". Nel caso di questa merceria, per esempio, abbiamo integrato il metro sul piano lavoro.

* The use of the back-printed top allows to give character to the point of sale with thematic prints. In this example we have integrated the meter picture on the working surface.

*Attenzione: l'elenco sopra è puramente indicativo, gli accessori possono essere utilizzati per più categorie merceologiche.
*Warning: The above list is only indicative, the accessories can be used for more than one category.

Pattern decorativo per il negozio di libri.

Decorative pattern for the bookstore.



1.2.3. Espositore libri. 4. Cash drawer. 5.6. Gradinale riviste. 7. Vano porta shoppers. 8. Cassettiera.

1.2.3. Books display. 4. Cash drawer. 5.6. Books step display. 7. Bags holder. 8. Chest of drawers.

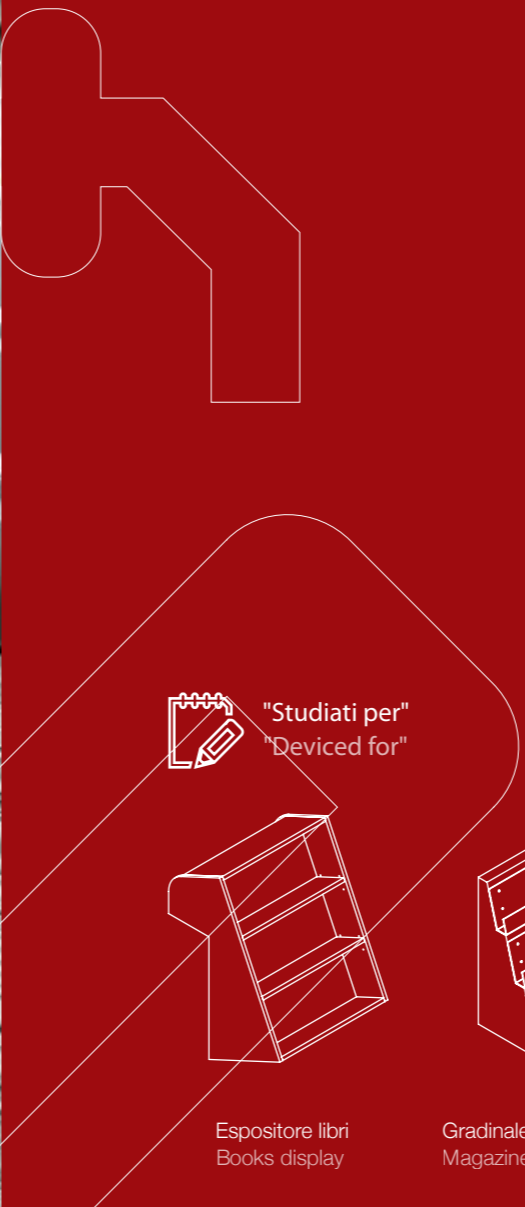

"Studiati per"
"Devised for"

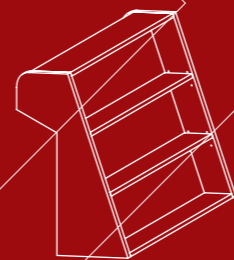

Espositore libri
Books display

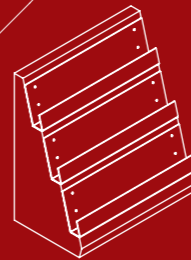

Gradinale per riviste inferiore
Magazines above step display



Gradinale per riviste superiore
Magazines below step display



Cash drawer
Cash drawer

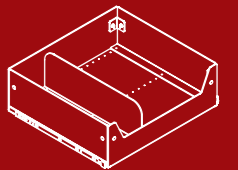

Vano porta shoppers
Bags holder



Cassettiera
Chest of drawers

*Attenzione: l'elenco sopra è puramente indicativo, gli accessori possono essere utilizzati per più categorie merceologiche.
*Warning: The above list is only indicative, the accessories can be used for more than one category.

Atmosfera classica ed elegante per il tabacchi. Classical and elegant atmosphere for the tobacconist.



1.2.3. Vetrina bassa. 4.5. Vetrina sigari "humidor". 6. Ripiano singolo con "spingi pacchetto".

1.2.3. Short glass case. 4.5. Cigar "humidor". 6. Single shelf with cigarette pack spring.

"Studiati per"
"Devised for"

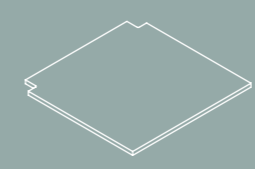

Ripiano singolo
Single shelf

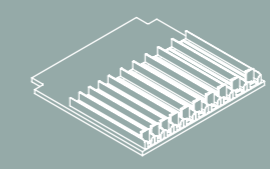

"Spingi pacchetto" sigarette
Cigarette pack spring



Vetrina sigari "humidor"
Cigar humidor

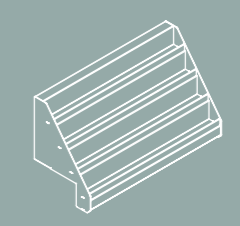

Gradinale porta caramelle
Candy step display

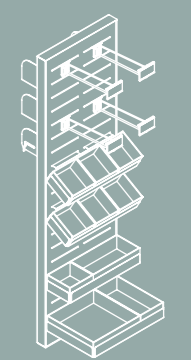

Totem espositivo
Display totem

*Attenzione: l'elenco sopra è puramente indicativo, gli accessori possono essere utilizzati per più categorie merceologiche.
*Warning: The above list is only indicative, the accessories can be used for more than one category.

Massima funzionalità per il negozio di fiori.

Maximum functionality for the flower shop.



1.2. Porta carta e taglierina.
3. Vano porta shoppers. 4.
Contenitore spazzatura. 5.
Cash drawer. 6. Cassettiera.

1.2. Wrap paper holder and
cutter. 3. Bags holder. 4.
Garbage bin. 5. Cash drawer.
6. Chest of drawers.

"Studiati per"
"Devised for"

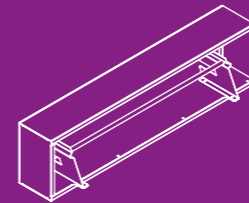

Porta carta e taglierina
Wrap paper holder and cutter

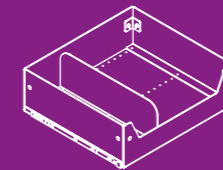

Vano porta shoppers
Garbage bin



Contenitore spazzatura
Bags holder



Cash drawer
Cash drawer



Cassettiera
Chest of drawers

*Attenzione: l'elenco sopra è puramente indicativo, gli accessori possono essere utilizzati per più categorie merceologiche.
*Warning: The above list is only indicative, the accessories can be used for more than one category.

"Dark cybernetic" per il mondo elettronica.

"Dark cybernetic" for the electronics world.



1.2. Vetrina con gradinale.
3. Piano "al tocco". 4. Gradinale esterno. 5.6. Vetrina incassata.

1.2. Tall glass case.
3. Touchable products surface. 4. External step display. 5.6. Vetrina incassata.



"Studiati per"
"Devised for"

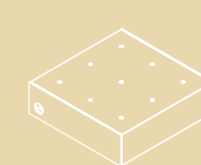

Piano "al tocco"
Touchable products surface



Display luminoso
Lit display



Vetrina alta
Tall glass case



Vetrina bassa
Short glass case



Vetrina incassata alta
Embedded tall glass case

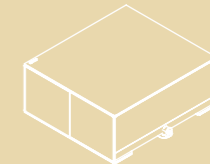

Vetrina incassata bassa
Embedded short glass case



Gradinale interno
Internal step display

*Attenzione: l'elenco sopra è puramente indicativo, gli accessori possono essere utilizzati per più categorie merceologiche.
*Warning: The above list is only indicative, the accessories can be used for more than one category.

stampato in Italia
printed in Italy

© **Gibam Shops srl**

novembre 2012
november 2012

progetto studio tecnico Gibam Shops
layout scheme Gibam Shops technical dep.

design di Nicola De Pellegrini - Anidride design
design Nicola De Pellegrini - Anidride design

render Alessandro Pregolato
render Alessandro Pregolato

**è vietata la riproduzione totale o parziale del catalogo senza
previa autorizzazione di Gibam Shops srl**
the present printed material cannot be partially or totally reproduced
unless Gibam Shops srl has granted permission to do so

Follow us also on:



Numero Verde
800 050 640

WWW.GIBAMCOMPOSIT.IT

Gibam Composit è un prodotto:

GIBAM SHOPS SRL
VIA L.EINAUDI, SN
61032 BELLOCCHI DI FANO (PU)
TEL. +39 0721 85991
FAX +39 0721 854015

WWW.GIBAMSHOPS.IT
INFO@GIBAMSHOPS.IT

GIBAM SHOPS



 GRUPPO **GIBAM**